



ARRL Periodicals Archive – Search Results

A membership benefit of ARRL and the ARRL Technical Information Service

ARRL Members: You may print a copy for personal use. Any other use of the information requires permission (see Copyright/Reprint Notice below).

Need a higher quality reprint or scan? Some of the scans contained within the periodical archive were produced with older imaging technology. If you require a higher quality reprint or scan, please contact the ARRL Technical Information Service for assistance. Photocopies are \$3 for ARRL members, \$5 for nonmembers. For members, TIS can send the photocopies immediately and include an invoice. Nonmembers must prepay. Details are available at www.arrl.org/tis or email photocopy@arrl.org.

QST on CD-ROM: Annual CD-ROMs are available for recent publication years. For details and ordering information, visit www.arrl.org/qst.

Non-Members: Get access to the ARRL Periodicals Archive when you join ARRL today at www.arrl.org/join. For a complete list of membership benefits, visit www.arrl.org/benefits.

Copyright/Reprint Notice

In general, all ARRL content is copyrighted. ARRL articles, pages, or documents--printed and online--are not in the public domain. Therefore, they may not be freely distributed or copied. Additionally, no part of this document may be copied, sold to third parties, or otherwise commercially exploited without the explicit prior written consent of ARRL. You cannot post this document to a Web site or otherwise distribute it to others through any electronic medium.

For permission to quote or reprint material from ARRL, send a request including the issue date, a description of the material requested, and a description of where you intend to use the reprinted material to the ARRL Editorial & Production Department: permission@arrl.org.

QEX Issue: May 2005

Title: A Multi-Output Power Supply for the Experimenter

Author: John B. Stephensen, KD6OZH

[Click Here to Report a Problem with this File](#)



2009 ARRL Periodicals on CD-ROM

ARRL's popular journals are available on a compact, fully-searchable CD-ROM. Every word and photo published throughout 2009 is included!

- **QST** The official membership journal of ARRL
- **NCJ** National Contest Journal
- **QEX** Forum for Communications Experimenters

SEARCH the full text of every article by entering titles, call signs, names—almost any word. **SEE** every word, photo (including color images), drawing and table in technical and general-interest features, columns and product reviews, plus all advertisements. **PRINT** what you see, or copy it into other applications.

System Requirements: Microsoft Windows™ and Macintosh systems, using the industry standard Adobe® Acrobat® Reader® software. The Acrobat Reader is a free download at www.adobe.com.

2009 ARRL Periodicals on CD-ROM

ARRL Order No. 1486
Only **\$24.95***

*plus shipping and handling

Additional sets available:

2008 Ed., ARRL Order No. 9406, \$24.95
2007 Ed., ARRL Order No. 1204, \$19.95
2006 Ed., ARRL Order No. 9841, \$19.95
2005 Ed., ARRL Order No. 9574, \$19.95
2004 Ed., ARRL Order No. 9396, \$19.95
2003 Ed., ARRL Order No. 9124, \$19.95
2002 Ed., ARRL Order No. 8802, \$19.95
2001 Ed., ARRL Order No. 8632, \$19.95



ARRL The national association for **AMATEUR RADIO™**

SHOP DIRECT or call for a dealer near you.

ONLINE WWW.ARRL.ORG/SHOP

ORDER TOLL-FREE 888/277-5289 (US)

A Multi-Output Power Supply for the Experimenter

The author describes a power-supply design that can be adapted to most projects that include modern solid-state devices.

By John B. Stephensen, KD6OZH

Introduction

If you're an avid builder of homebrew Amateur Radio equipment, one item that has to be replicated over and over again is the power supply. Radios that incorporate both analog and digital circuitry generally require three or four voltages. There are off-the-shelf multi-output power-supply units available, but the output voltages are generally inappropriate for today's semiconductors. A decade ago, a power supply with +5, +12 and -12 V outputs would have been suitable for most receiver and low-power transmitter projects. Requirements have changed.

Modern logic devices no longer operate from 5-V supplies, but use 3.3-V supplies for input/output pins plus component-specific supply voltages to power the core logic. On-board regulators are best for supplying core voltages of 2.5, 1.8, 1.5 or 1.2 V, but a high-current 3.3-V output is a must in any multi-output supply.

Analog components such as operational amplifiers (op amps) and the analog side of mixed-signal devices now use 5 V, so a clean low-current 5-V supply is still necessary.

VHF, UHF and microwave equipment often uses monolithic microwave integrated circuits (MMICs) that require a supply voltage between 2.5 and 5.5 V. This is usually supplied through an RF choke and a dropping resistor that set the operating current of the device. It is important that the drop-

ping resistor not dissipate too much power but a power supply output significantly higher than the highest MMIC terminal voltage is required. I selected 7.5 V as the best compromise. Several amperes may be required for projects using high-power MMIC amplifiers.

A component that should see increasing use in amateur projects is the current-feedback (CFB) op amp. These are similar to traditional voltage-feedback op amps but have slew rates of several thousand V/ μ sec. They are relatively low-noise devices and their high speed allows use in RF circuits at frequencies up to 150 MHz. Devices may operate at 10-15 V, but a higher voltage results in lower distortion. A 15-V output supplying several hundred mA is a must.

Many modern receivers and trans-

3064 E Brown Ave
Fresno, CA 93703-1229
kd6ozh@verizon.net

mitters use voltage-controlled oscillators (VCOs) since components for mechanically tuned oscillators are no longer manufactured. The varactor diodes used to tune these oscillators

have breakdown voltages between 12 and 30 V. The parts with the highest Q generally require high voltages, so an output at 24 V is necessary. Since the diodes are reverse biased, only a

few milliamps of current is required. Designing a new power supply for each project is not the most interesting exercise, so I decided to design a low-cost power supply to provide all

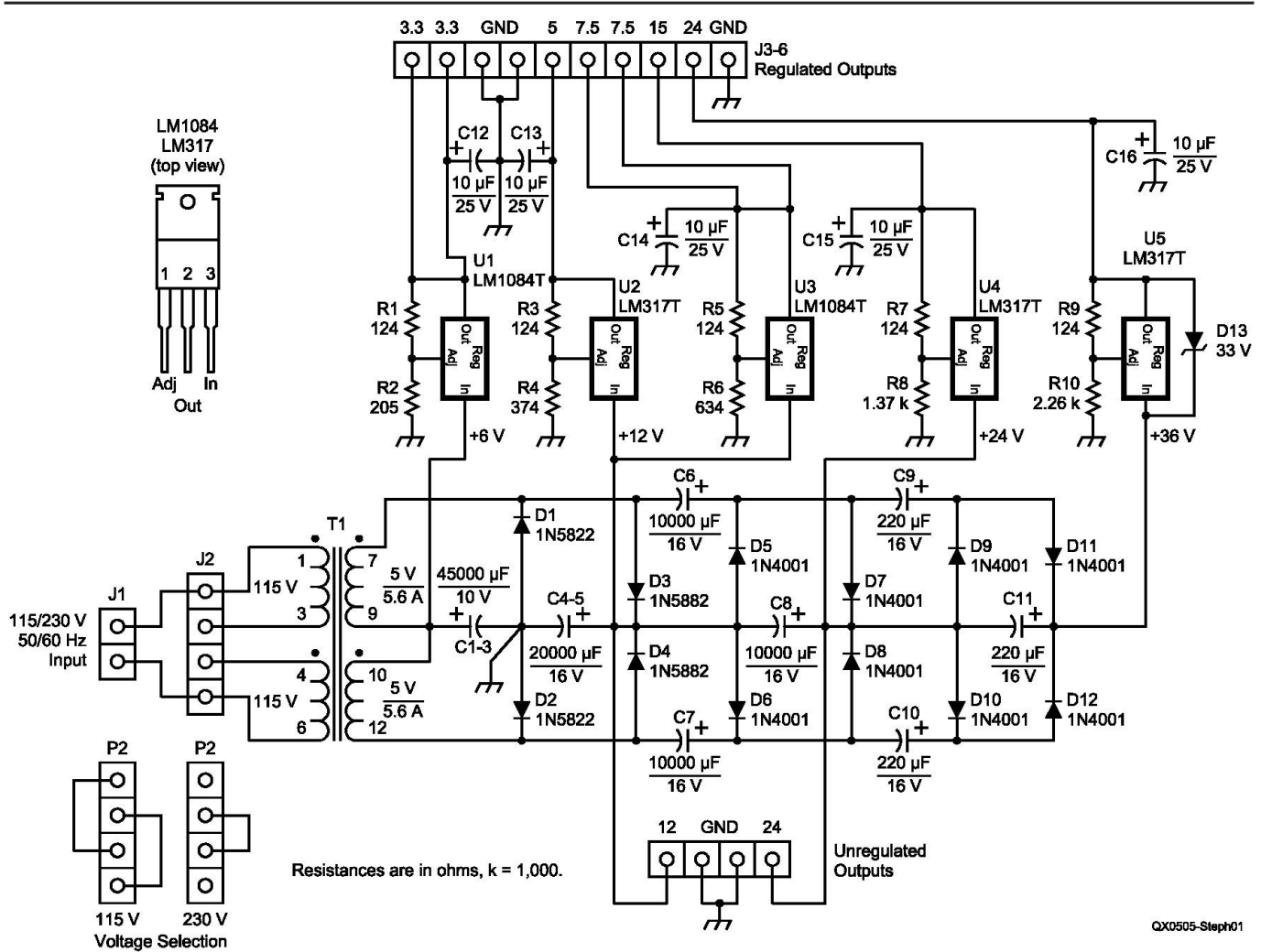

QX0505-Step01

Fig 1—Schematic of the multi-voltage power supply. Unless otherwise specified, use axial lead, 1/4 W, 1% resistors.

- C1-C3—Capacitor, radial lead, aluminum electrolytic, 15000 µF +80/-20%, 10 WVdc, 3/4" max. OD, 0.3" LS Nichicon UVR1A153MHD, Panasonic ECA-1AM153
- C4-C8—Capacitor, radial lead, aluminum electrolytic, 10000 µF +80/-20%, 16 WVdc, 3/4" max. OD, 0.3" LS Nichicon UVR1C103MHD, Panasonic ECA-1CM103
- C9-C11—Capacitor, radial lead, aluminum electrolytic, 220 µF +80/-20%, 16 WVdc, 1/4" max. OD, 0.1" LS Nichicon UVR1C221MHD, Panasonic ECA-1CM221
- C12-C16—Capacitor, radial lead, tantalum electrolytic, 10 µF, 25 WVdc, 1/4" max. OD, 0.1" LS AVX TAP106K025SCS, Kemet T350E106K025AS
- D1-D4—Schottky rectifier, 3 A, 40 PIV, 1N5832
- D5-D12—Rectifier, 1 A, 50 PIV, 1N4001
- D13—Zener diode, 1 W, 33 V, 1N4752

- J1—Header, 2 position, 0.045" sq pin, 0.156" spacing, Amp 640445-2, Molex/Waldom 26-48-1025
- J2—Header, 4 position, 0.045" sq pin, 0.156" spacing, Amp 640445-4, Molex/Waldom 26-48-1045
- J3-J6—Header, 10 position, 0.025" sq pin, 0.1" spacing, Amp 1-640454-0, Waldom/Molex 22-23-2101
- J7—Header, 4 position, 0.025" sq pin, 0.1" spacing, Amp 640454-4, Waldom/Molex 22-23-2041
- R1, R3, R5, R7, R9—124 Ω, Digi-Key 124XBK-ND, Panasonic ERD-S2TJ124V
- R2—205 Ω Digi-Key 205XBK-ND, Panasonic ERD-S2TJ205V
- R4—374 Ω Digi-Key 374XBK-ND, Panasonic ERD-S2TJ374V
- R6—634 Ω Digi-Key 634XBK-ND, Panasonic ERD-S2TJ634V
- R8—1370 Ω Digi-Key 1.37KXBK-ND, Panasonic ERD-S2TJ1.37KV

- R10—2260 Ω Digi-Key 2.26KXBK-ND, Panasonic ERD-S2TJ2.26KV
- T1—Transformer, 56 VA, dual 115-V 50-60 Hz primary, dual 5-V secondary Tamura PL56-10-130B, PPC VPP10-5600
- T1 (alternate, see text)—Transformer, 30 VA, dual 115 V, 50-60 Hz primary, dual 5 V secondary windings Tamura PL30-10-130B, PPC VPP10-3000
- U1—Voltage regulator, LDO, adjustable, 5 A, TO-220, National LM1084IT, Linear Technology LT1084CT
- U2, U4, U5—Voltage regulator, adjustable, National LM317TNS, Linear Technology LT317AT
- U3—Voltage regulator, LDO, adjustable, 5 A, TO-220, National LM1084IT Linear Technology LT1084CT
- U3 (alternate, see text)—Voltage regulator, LDO, adjustable, 3 A, TO-220 National LM1085IT, Linear Technology LT1085CT

necessary voltages. This supply can be replicated and re-used for various projects in the future. The design is described here and PC boards are available from the author to allow easy replication by others. All parts are readily available and the parts list provides two manufacturers' part numbers for each component. No surface-mount components are used and all may be ordered on-line from Digi-Key or other suppliers.

Circuit Description

The power supply uses linear voltage regulators to avoid electromagnetic interference (EMI) generation. In order to provide reasonable efficiency the unregulated input voltage to each linear regulator cannot be too high or most of the power will be dissipated in the regulator. Since the output voltages span an 8 to 1 range, some design tricks were required to generate multiple voltages from an inexpensive off-the-shelf transformer.

The power supply circuit, shown in Fig 1, uses a transformer with a 10-V center-tapped secondary winding and voltage multiplier circuitry to generate four unregulated voltages. The two primary windings may be connected in series or parallel to support 105 to 125-V or 210 to 250-V inputs at 50 to 60 Hertz. Note that the filter capacitor values are kept small to minimize the power factor. Ripple can reach 20% at high currents but the regulators attenuate this by a factor of 1000 or more at the outputs.

A half-wave rectifier formed by D1, D2, C1, C2 and C3 provides the lowest voltage. This may range from 5 to 8 V depending on line voltage and output current. D1 and D2 are low-loss Schottky rectifiers. A 5-A adjustable regulator consisting of U1, R1, R2 and C12 converts this to 3.3 V.

A bridge rectifier circuit consisting of D1-D4, C4 and C5 provides the next highest voltage. This may range from 10 to 16 V. D1-D4 are Schottky diodes in order to minimize forward voltage drop. Two linear regulators, U2 and U3, provide 5-V and 7.5-V outputs. U2 is a 1.5-A regulator and U3 is a 5-A regulator.

C6-C8 and D5-D8 form a full-wave voltage doubler circuit. C6 and C7 are alternately charged through D5 and D6 when the voltage on the transformer secondary drops below the voltage on C4 and C5. When the voltage rises towards its peak, these capacitors discharge into C8 through D7 and D8. Their positive ends reach almost twice the transformer voltage and a 20-32 V unregulated supply is created.

U4, R7, R8 and C15 regulate this down to 15 V at up to 1.5 A.

D7-D10 and C9-C11 operate similarly to form a voltage tripler that generates 30-48 V. U5 converts this to 24 V dc. Since only a small current is needed, C9-C11 are 220 μ F capacitors. U5 is only rated to 40 V so D13 clamps the input to output voltage to 33 V in case the 24-V output is short-circuited. The small values of C9-C11 provide current limiting. 20 mA of output current is available.

Component Options

When installing components note their polarity. Pins 1, 3, 4 and 6 are the transformer primary winding and must be located near the end of the PCB. The cathode end of rectifiers is marked with a band on the component and a "K" on the top of the board. The positive end of capacitors is marked with a "+" on the component and the board.

The PC board is laid out for square-pinned headers. The input connectors, J1 and J2 use 45-mil square pins on a 156-mil spacing so that the mating connectors can accommodate 18-AWG wire. J1 is the ac line input and J2 is used to select the input voltage range as shown in Fig 1. These connectors can be eliminated, if desired, and the ac input soldered to the mounting holes.

J3-J6 use 25-mil square pins on a 100-mil spacing and the mating connectors can accommodate up to 22-AWG wire. The high-current outputs use 2 pins so that up to 4 A can be

supported per connector. One to four connectors can be installed, depending on requirements, or the outputs can be hard-wired.

J7 is a 4-pin 100-mil spacing connector that provides two unregulated voltage outputs. These are meant for 12-V and 24-V relay coils but can vary from 10-16 and 20-32 V depending on line voltage and total load current.

The PCB can accommodate two transformer styles. A 56-W transformer must be used for full output current or a 30-W transformer may be installed when less current is required. Up to 36 W can be drawn from the seven dc outputs when the 56-W transformer is used.

If the 30-W transformer is used, C3 and C4 may be removed and U3 must be changed to a 3-A voltage regulator IC. The total available power output drops to 20 W. See the schematic for the component options.

The output voltage for each regulator may be changed by using different value resistors at R2, R4, R6, R8 and R10. I only recommend lowering the voltage at U1-U4, as the input voltage to the regulator may be inadequate for higher dc output voltages. The output of U5 may be increased up to 28 V.

Installation

The PCB has holes for six #4-40 mounting screws. Use all six so that the transformer and output connectors are adequately supported. Use 3/8-inch or longer standoffs so that the ac input



Fig 2—Photo of completed power supply.

connectors cannot touch the chassis. The voltage regulators, U1-U5 require heat sinks if more than 2 W are drawn from any output. The board is

designed with all regulators at one end so that all may be attached to a common heat sink. The heat sink often can be the chassis or cabinet used to house

the project. One or two six-inch lengths of aluminum channel stock may be mounted to the outside of the cabinet to enhance the thermal conductivity.

The voltage regulator ICs mount to a heat sink with five screws and five 5/32-inch holes are required are on 1/2-inch centers. Since the metal tabs on the TO-220 packages are at the output potential, they must be insulated from the heat sink with mica or composite insulators. The mounting screws may be #6-32 nylon or #4-40 metal screws may be used with insulated shoulder washers. If the power supply is run at full output, the heat sink must have a thermal resistance of 4°/W or less if the ambient temperature is above 35°C. You can check the adequacy of the heat sink by measuring the temperature of the TO-220 tabs. They will operate at 100°C but should be below 75°C for long life.

If the headers are used to connect the power-supply output, four may be installed when Waldom/Molex C-Grid crimp connector housings are used. If Amp MTA series IDC connectors are to be used, install only two headers with a gap between them.

This power supply has proven very versatile and the 4x6-inch PCB makes duplication easy. I'm currently using one for a bench supply and one in a software-defined radio. I'm sure that it will find many other uses.

John Stephensen, KD6OZH, became interested in radio at age 11, when his father bought him a crystal radio kit. During the 1960s, he built several HF receivers using vacuum tubes and other parts procured from discarded black-and-white TV sets. After attending the University of California, he and two friends founded PolyMorphic Systems, a supplier of personal computer kits, and later manufactured computers, in 1975. In 1985, he was cofounder of Retix, a networking hardware and software supplier. John received his Amateur Radio license in 1991 and has been active on bands from 7 MHz to 24 GHz, with interests including HF and microwave DXing and contesting. He has also been active on packet, satellites and on the HF bands using several digital modes. John has always designed and built his own Amateur Radio gear, some of which has been described in QEX articles in recent years. His latest projects have centered on high-speed digital communication using DSP. □□

**ARE YOU BUILDING A HIGH POWER AMPLIFIER?
DO YOU WANT TO TAKE A LIGHT-WEIGHT ON A TRIP?**

You must check out the PS-2500A High Voltage Power Supply

- 240VAC IN/2.5KVDC @ 1.1A OUT
- WEIGHT: 10 LBS
- Size: 11 3/4 X 5 5/8 X 5 INCHES
- RF "QUIET"
- FOR BUILT-IN OR OUTBOARD USE
- NEW CONSTRUCTION OR RETROFIT
- TWO MAY BE CONNECTED IN OUTPUT SERIES AND PARALLEL FOR HIGHER V AND I



**\$625 KIT/\$738 BUILT AND TESTED (POSTPAID IN CNTL US)
FOR FULL SPECS AND EASY ONLINE ORDERING, VISIT
WWW.WATTSUNLIMITED.COM**

Flash Crystal Frequency Synthesizer



- **Clean, Stable RF Signal Source** – Great for local oscillators and lab test equipment applications!
- **Several Models Available** – Covering from 7 MHz up to 148 MHz
- **Can Store Up to 10 Frequencies** – Board-mounted mini rotary dip switch for frequency selection
- **Completely Re-Programmable** – Program the 10 frequencies using any PC running *Hyperterminal* (included in *Windows* operating systems)
- **Economical** – A fraction of the cost of a comparable lab-grade RF signal synthesizers
- **Outputs Approximately 5 mW (+7 dBm)** – Female SMA RF output connector
- **Fully Assembled, Tested, and Ready to Go!** – Just \$80 (plus \$4.30 S/H in US)
- **Super Compact** – Measures less than 2 by 2 inches!
- **Power Requirements** – 8 to 15V dc at approximately 55 mA

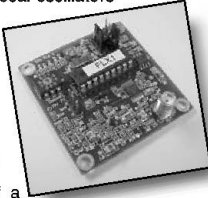

HC-49 Crystals

- Frequencies: 3535, 3560, 7030, 7038, 7040, 7042, 7058, 7122, 7190, 7195, 10106, 10125, 10700, 14057, 14058, 14060, 21060, 24906, 28060, 28238, 28258 kHz
- Specs: +/-100 ppm, 18 pf

Cylindrical Crystals

- Frequencies: 3560, 7030, 7038, 7040, 7042, 7190, 10106, 10125, 14025, 14200, 14285, 18096, 21026, 21060, 24906, 28060 kHz.
- Specs: +/-100 ppm, 18 pF, 3x8 mm. (3560 crystal: 3x10 mm)

For Further Details, Visit Our Web site for the Owners Manual

**Expanded Spectrum Systems • 6807 Oakdale Dr • Tampa, FL 33610
813-620-0062 • Fax 813-623-6142 • www.expandedspectrumsystems.com**



ARRL
225 Main Street
Newington, CT 06111-1494 USA

For one year (6 bi-monthly issues) of QEX:

In the US

ARRL Member \$24.00
 Non-Member \$36.00

In the US by First Class mail

ARRL Member \$37.00
 Non-Member \$49.00

Elsewhere by Surface Mail
(4-8 week delivery)

ARRL Member \$31.00
 Non-Member \$43.00

Canada by Airmail

ARRL Member \$40.00
 Non-Member \$52.00

Elsewhere by Airmail

ARRL Member \$59.00
 Non-Member \$71.00

Remittance must be in US funds and checks must be drawn on a bank in the US. Prices subject to change without notice.

QEX Subscription Order Card

QEX, the Forum for Communications Experimenters is available at the rates shown at left. Maximum term is 6 issues, and because of the uncertainty of postal rates, prices are subject to change without notice.

Subscribe toll-free with your credit card **1-888-277-5289**

Renewal New Subscription





Name _____ Call _____

Address _____

City _____ State or Province _____ Postal Code _____

Payment Enclosed to ARRL

Charge:

Account # _____ Good thru _____

Signature _____ Date _____

06/01